

Features

- 20A switching capability
- We can provide the product with ambient temperature is 105°C
- The contact can withstand 750A 10ms short-circuit impulse current
- The contact on and off can be controlled by the hand control switch
- Can provide the product meet the standard of IEC60335-1
- UL insulation system:Class F
- Environment-friendly product(RoHS compliant)
- Outline Dimensions:(29.0×12.7×16.0)mm
- Main application:Smart home, Lighting control



TV-8 C  US

■ CHARACTERISTICS

Specifications	Item		
Contact Data	Contact arrangement		1A, 1B, 1C
	Contact resistance(initial)		≤50mΩ(6VDC 1A)
	Contact material		AgSnO ₂
Rated value	Rated load(Resistance load)		20A 250VAC 16A 250VAC (Standard)
	Max.switching voltage		277VAC
	Max.switching current		20A
	Max.switching capacity		5000VA
	Min.allowing load		5VDC 100mA
Electrical performance	Insulation resistance(initial)		1000MΩ(500VDC)
	Dielectric strength (initial)	Between open contacts	1000VAC, 1min
		Between coil&contacts	1A/1B:4000VAC, 1min 1C:3000VAC, 1min
	Set time		≤15ms
Reset time		≤15ms	
Mechanical performance	Shock resistance	Functional	98m/s ² (10G)
		Destructive	980m/s ² (100G)
Vibration resistance		10Hz~55Hz 1.5mm DA	
Endurance	Mechanical		1×10 ⁶ ops
	Electrical(Room temperature)		20A 250VAC 5×10 ⁴ ops(ON/OFF=1s/9s) 16A 250VAC 1×10 ⁵ ops(ON/OFF=1s/9s)
Operate condition	Ambient temperature		-40℃~85/105℃
	Humidity		5% to 90%
Termination			PCB
Unit weight			Approx.15g
Construction			Plastic sealed,Flux proofed

■ COIL DATA(23°C)

■ Single coil latching

Nominal Voltage	Set Voltage VDC	Reset Voltage VDC	Rated Current (±10%)	Coil Resistance (±10%)	Nominal Power	Max Voltage
DC 3V	≤2.4	≤2.4	166.7mA	18Ω	500mW	DC 4.5V
DC 5V	≤3.75	≤3.75	100mA	50Ω		DC 7.5V
DC 6V	≤4.50	≤4.50	83.3mA	72Ω		DC 9V
DC 9V	≤6.75	≤6.75	55.6mA	162Ω		DC 13.5V
DC 12V	≤9.00	≤9.00	41.7mA	288Ω		DC 18V
DC 24V	≤18.00	≤18.00	20.8mA	1152Ω		DC 36V
DC 36V	≤27.00	≤27.00	13.9mA	2592Ω		DC 54V
DC 48V	≤36.00	≤36.00	10.4mA	4608Ω		DC 72V

■ Double coils latching

Nominal Voltage	Set Voltage VDC	Reset Voltage VDC	Rated Current (±10%)	Coil Resistance (±10%)	Nominal Power	Max Voltage
DC 3V	≤2.4	≤2.4	333.3/333.3mA	9/9Ω	1000mW	DC 4.5V
DC 5V	≤3.75	≤3.75	200/200mA	25/25Ω		DC 7.5V
DC 6V	≤4.50	≤4.50	166.7/166.7mA	36/36Ω		DC 9V
DC 9V	≤6.75	≤6.75	111.1/111.1mA	81/81Ω		DC 13.5V
DC 12V	≤9.00	≤9.00	83.3/83.3mA	144/144Ω		DC 18V
DC 24V	≤18.00	≤18.00	41.7/41.7mA	576/576Ω		DC 36V
DC 36V	≤27.00	≤27.00	27.8/27.8mA	1296/1296Ω		DC 54V
DC 48V	≤36.00	≤36.00	20.8/20.8mA	2304/2304Ω		DC 72V

■ ORDERING INFORMATION

W15L -1A 1 S T M -L1 R -XXX DC12V

- ① Type
- ② Contact arrangement: 1A=1 open contacts
1B=1 close contacts
1C=1 switched contacts
- ③ PCB mounting: 1=type 1, 2=type 2, 3=type 3
5=type 5, 6=type 6
- ④ Construction(1): Nil=Flux proofed, S=Plastic sealed
- ⑤ Contact material: T=AgSnO₂
- ⑥ Control type: Nil=No hand control switch,
M=Within Manual Switch, (Plastic sealed type and 1C type are unavailable)
- ⑦ Coil type: L1=coil latching, L2=coils latching
- ⑧ Operation polarity: Nil=standard polarity R=reversed polarity
- ⑨ Customer special code: numbers or letters denote customer's requirements
- ⑩ Coil specification: DC3/5/6/9/12/24/36/48V

OUTLINE DIMENSIONS, WIRING DIAGRAM AND PC BOARD LAYOUT (Unit:mm)

1A6/1B6 Outline Dimensions
(Double coils latching)

Wiring Diagram
(Bottom view)

PCB Layout
(Bottom view)

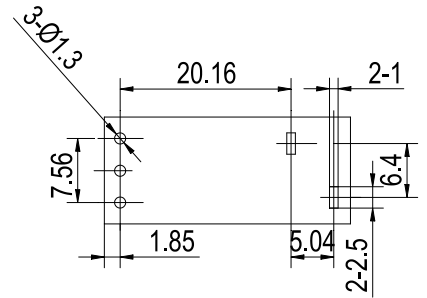
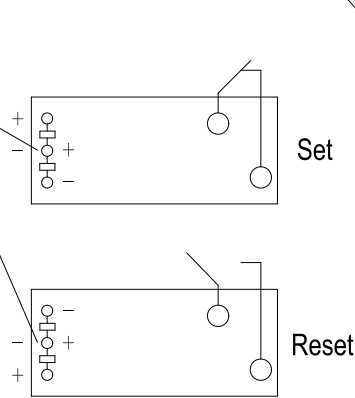
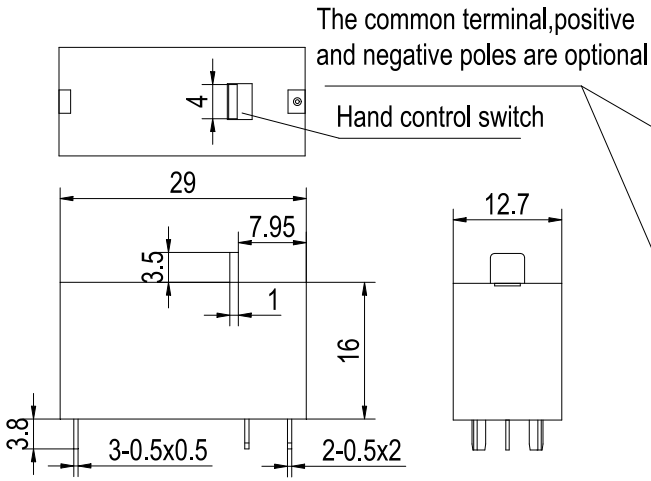

1C2 Outline Dimensions
(Single coil latching)

Wiring Diagram
(Bottom view)

PCB Layout
(Bottom view)

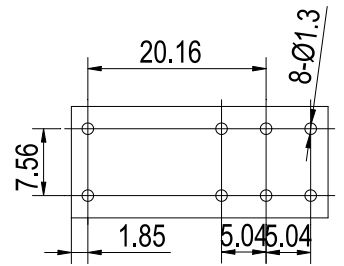
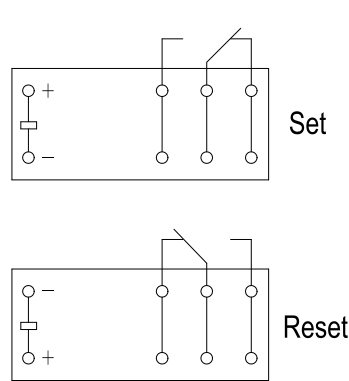
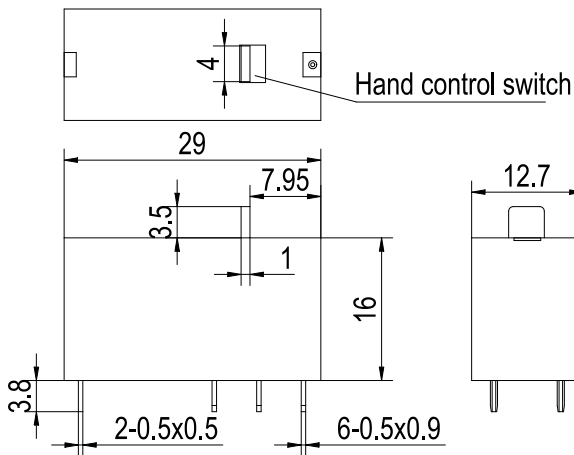

1C2 Outline Dimensions
(Double coils latching)

Wiring Diagram
(Bottom view)

PCB Layout
(Bottom view)

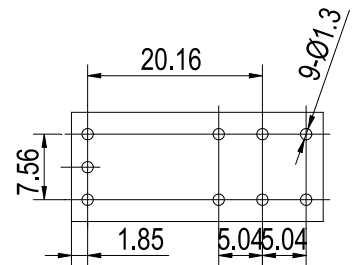
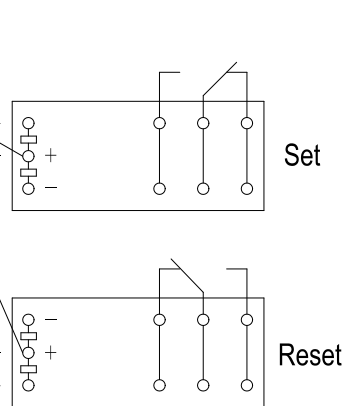
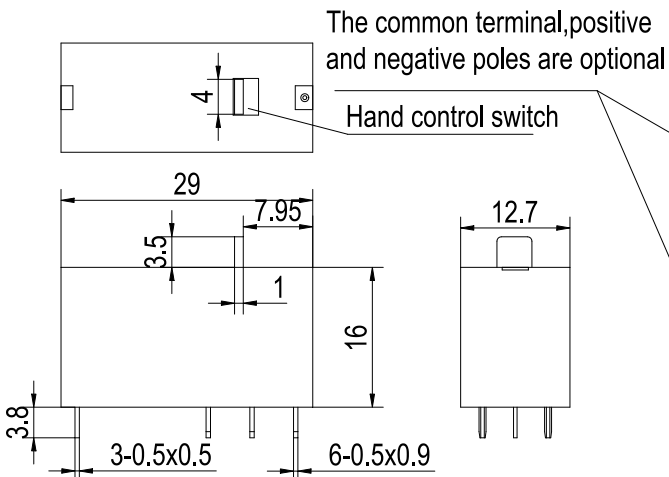

OUTLINE DIMENSIONS, WIRING DIAGRAM AND PC BOARD LAYOUT (Unit:mm)

1C5 Outline Dimensions
(Single coil latching)

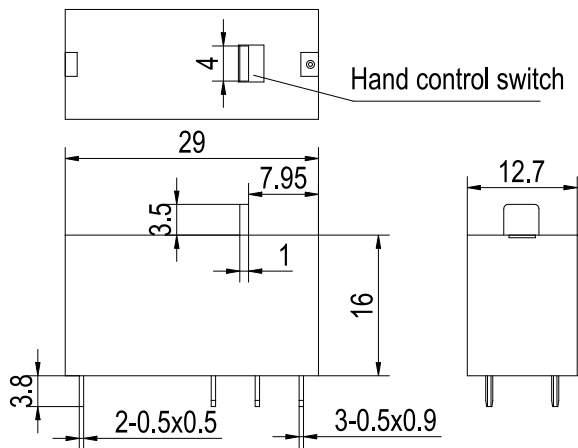

Wiring Diagram
(Bottom view)

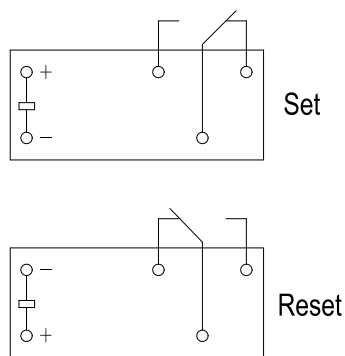

PCB Layout
(Bottom view)

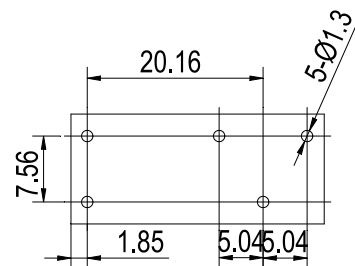

1C5 Outline Dimensions
(Double coils latching)

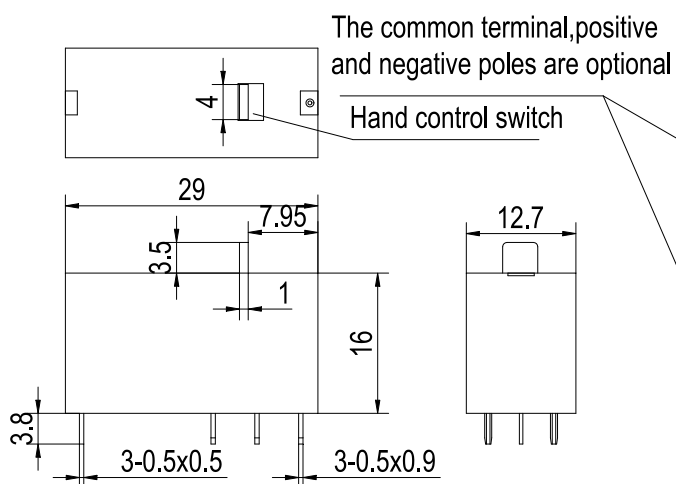

Wiring Diagram
(Bottom view)

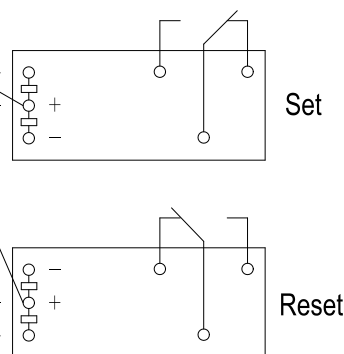

PCB Layout
(Bottom view)

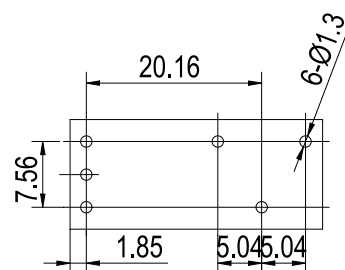

Remark: (1) In case of no tolerance shown in outline dimension: outline dimension ≤ 1 mm, tolerance should be ± 0.2 mm; outline dimension > 1 mm and < 5 mm, tolerance should be ± 0.3 mm; outline dimension ≥ 5 mm, tolerance should be ± 0.5 mm.

(2) The tolerance without indicating for PCB layout is always ± 0.1 mm.

SAFETY APPROVAL RATINGS

Approval	File No.	Contact arrangement	Contact material	Approved ratings	
UL/C-UL	E475405	1A, 1C(NO)	AgSnO ₂	16A 250/125VAC	85/105°C
				20A 250/125VAC	85°C
				1/2HP 120VAC	85°C
				1200W 120VAC(osram lamp, LED lamp)	85/105°C
				10A 250VAC(PF=0.4)	85°C
				TV-8 250/125VAC	85°C
		1B, 1C(NC)		16A 250/125VAC	85/105°C
				20A 250/125VAC	85°C
				1/2HP 120VAC	85°C
				1200W 120VAC(osram lamp, LED lamp)	85/105°C
				10A 250VAC(PF=0.4)	85°C
				TV-8 250/125VAC	85°C
TUV	R 50401990	1A(NO) 1B(NC)	AgSnO ₂	16A 250/125VAC	85°C
				20A 250/125VAC	85°C
CQC	CQC18002187939	1A(NO)	AgSnO ₂	20A 250/125VAC	85°C
				16A 250/125VAC	85°C
		1B(NC)		16A 250/125VAC	85°C

PERFORMANCE CURVES

MAXIMUM SWITCHING POWER

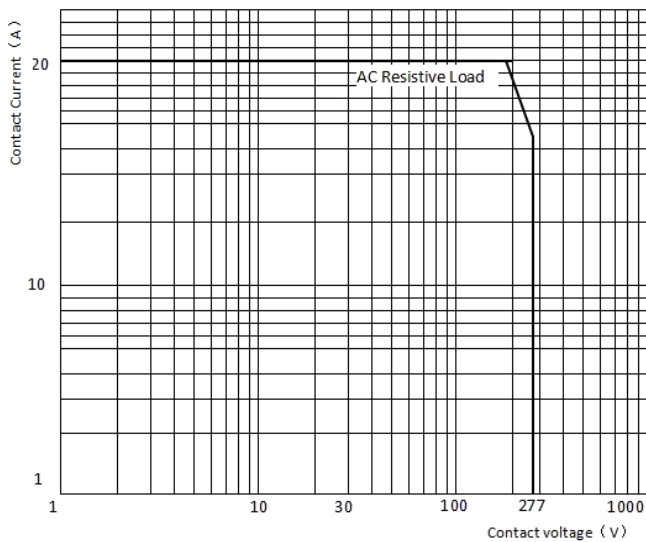

ENDURANCE CURVE

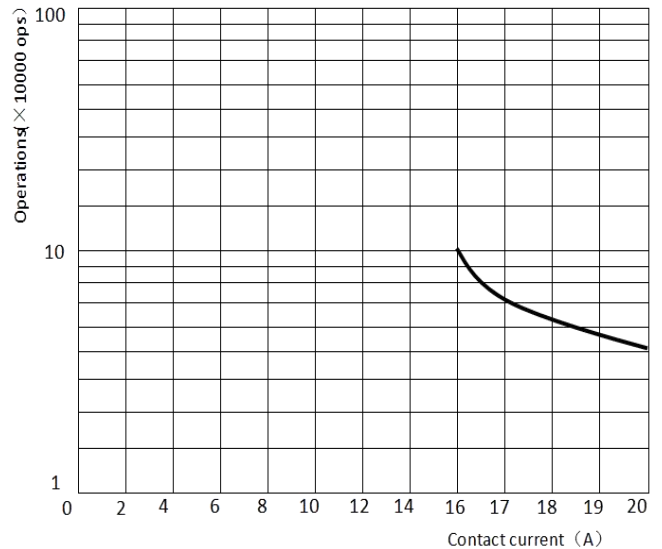

■ NOTICE

- ① With the consideration of shock risen from transit and relay mounting, relay's initial state might be changed ,please impose pulse voltage to reset the relay before using(rated coil voltage,impulse width \geq 5 times operation time.
- ② In order to maintain the initial performance parameters of the relay, please be careful not to drop the product;
- ③ In order to maintain the "set" or "reset" status, energized voltage to coil should reach the rated voltage, impulse width should be 5 times more than "set" or "reset" time. Do not energize the voltage to "set" coil and "reset" coil simultaneously.
- ④ The specification is for reference only.Specifications subject to change without notice.